

Article number: 20940653

Description: E+G Clamping bolt
GN 802-M8-63

Measures

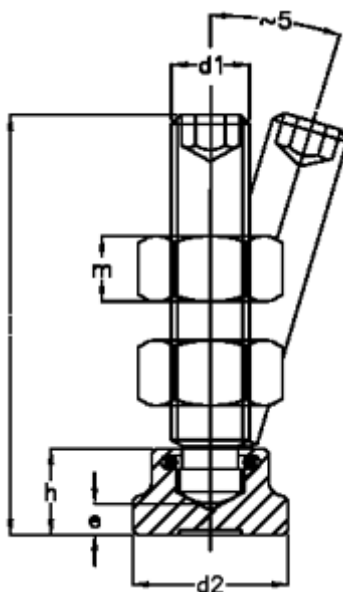

d1 = M8

d2 = 16

e = 3

h = 9

l1 = 63

m = 6.8